

Varenummer: 2301044211  
 Beskrivelse: E+G Håndsving  
 MT.80 AS-10x10

## Mål

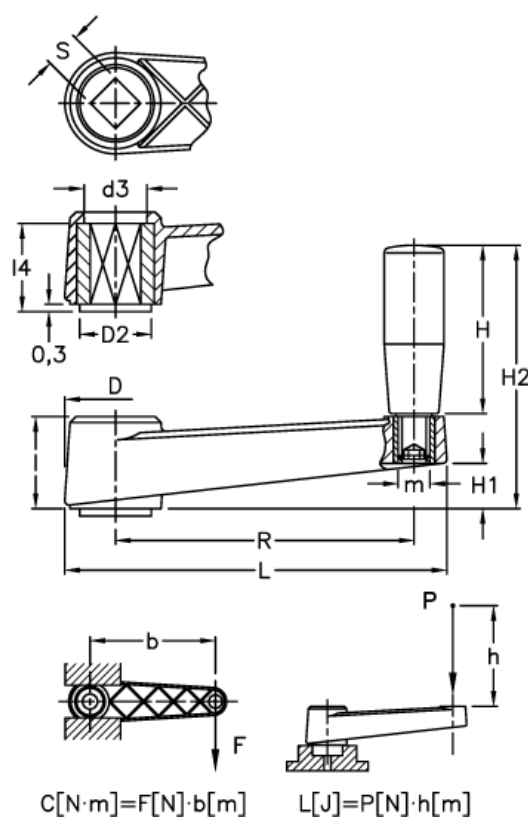

C (N*m) = 180	L = 105
D = 30	L(J) = 15
d2 = 20	l4 = 22
d3 = 17	m = M6
H = 50	R = 80
H1 = 13	S H9 = 10x10
H2 = 76	
l = 26	